

“What Hope! An Eden Prophesied”

“In the Bleak Midwinter” is a beloved Christmas carol based on a poem by the English poet Christina Rossetti. “Bleak”—now there’s a descriptive word! In the poem and carol it bespeaks the dreary cold and stale snow that drags on week after week; yet in the midst of winter, God broke into history with the festive Nativity of His Son, our Savior. From “bleak” and “dreary” to “joy” and “hope!”

These days give a new sense of anguish to the word “bleak”! Sexual perversions are accepted and taught; yet it seems each day a sexual scandal is breaking news; anger and hostility abound from the ballfields to the backyard fence and are part of every political issue; etc. — yeah, these days are certainly “bleak”! We need hope! We need good news! We need the promise of a fallen humanity restored! My friends, that hope and promise is only found in the Messiah, the long-promised Savior, who comes restore us to God’s paradise! The *only* way!

Of the twenty-seven hymns in our hymnal that are specifically considered “Advent” hymns—hymns that prepare our hearts for the “coming” of Christ—two of these hymns are *new* to our hymnody. Both are delightful and inspirational. But let’s consider “What Hope! An Eden Promised” (LSB 342) as a hymn that brings hope and good news and the promised restoration we so need in these bleak days. Please read or sing through the hymn (below). ...

There are many allusions to Scripture in this short hymn, but it really focuses on Isaiah 11. I encourage you to read that text now as well. ...



“What hope! An Eden prophesied Where tame live with the wild...” Can you imagine a wolf dwelling with a lamb? ...or a leopard with a goat? ...or a cow with a bear? Such things just don’t happen! Such things are not natural! “The lamb and lion side by side, Led by a little child!” When God sends

His Son, nature itself is changed by His glorious appearing!

This is the “shoot sprouting from Jesse’s stem, a branch from David’s line, a Prince of Peace in Bethlehem: The fruit of God’s design.” Indeed, this was God’s eternal plan—a plan He established before the foundation of the world—to save mankind from the consequences of sin! Jesus came to Bethlehem as a vulnerable infant, yet He was the Prince of Peace, the only one who could restore fallen humanity with the holy God!

The third stanza takes us to the cross! *The banner, or flag, of God’s love is unfurled*—what a glorious sight! As we see His banner of love unfurled we take hope! ...even though it meant the suffering and death of Jesus! Good Friday is “Good” Friday because His death brings us forgiveness and life! That’s what draws us to rally to the cross! But, my friends, the season and

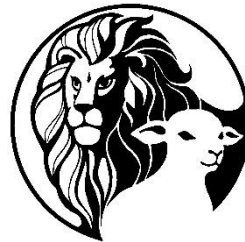

message of Advent is not just about His coming (historically) to Bethlehem, but that He also comes to our hearts today as we hear and sing His Word! Come into *my* heart, Lord Jesus! Come and take *my* sin! Come and dwell as *my* Messiah / Savior! Come and open heaven’s door for me!

Recall that when Adam and Eve fell into sin (and all mankind fell with them), that God placed an angel at the entrance of the Garden of Eden with a flaming sword that none would enter... *Lord, in this Advent season, lead me past the angel’s flaming sword and carry me on toward heaven that I may sing the joy of His birth in Bethlehem and His presence among us so that amid this world’s bleak and dreary days we would have true hope and be prepared to welcome Him in our hearts!*

We have joy in this Prince of Peace ...let’s sing!

Pastor Michael K. Heidle

I believe, therefore I speak... 2 Cor.4:13

LSB 342 “What Hope! An Eden Prophesied”



- 1 What hope! An E - den proph - e - sied Where tame live with the wild;
- 2 A shoot will sprout from Jes - se’s stem, A branch from Da - vid’s line,
- 3 As ban - ner of God’s love un - furled, Christ came to suf - fer loss,
- 4 Come, Je - sus, come, Mes - si - ah Lord, Lost Par - a - dise re - store:

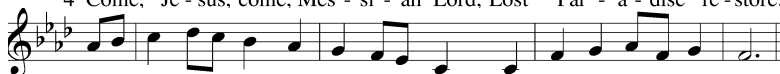

The lamb and li - on side by side, Led by a lit - tle child!
A Prince of Peace in Beth - le - hem: The fruit of God’s de - sign.
That by His death a dy - ing world Would ral - ly to the cross.
Lead past the an - gel’s flam - ing sword—Come, o - pen heav - en’s door.

SPECIAL DATES IN DECEMBER:



- 1st Sunday in Advent, **Dec. 3**
- 2nd Sunday in Advent, **Dec. 10**
- 3rd Sunday in Advent, **Dec. 17**
- 1st Day of Winter, **Dec. 21**
- 4th Sunday in Advent, **Dec. 24**
- Christmas Eve, **Dec. 24**
- Christmas Day, **Dec. 25**
- New Years' Eve, **Dec. 31**

HELP US CARE FOR YOU: When you or a family member enters the hospital; please let the hospital know during the admission process that you are a member of Immanuel Lutheran Church in Danville. The best option for us to serve you with prayers and visits is for you to call the church office when you or a family member enter the hospital or have any medical/surgical procedure. Your well-being is important to us and we want to pray for you! For any time of spiritual need, please call the church office: **217-442-5675** or Pastor Heidle's cell phone: 217-516-0085. **Prayer requests:** we are certainly pleased to pray for your (non-member) family and friends alongside our Immanuel members. Please keep us informed of their needs/improvements. Typically, we will keep them on our prayer list for a couple of weeks unless the request is renewed; but please know that many of our member will continue to pray for them. If their condition is more ongoing, simply renew the prayer request by speaking to Pastor or calling the church office and we will be happy to keep them in our congregational prayers! Just give us an update and let us know how we can help.

2018 ENVELOPES are coming soon! Please do not use your new envelopes until 2018 as your envelope number may have changed; likewise, do not use leftover 2017 envelopes after Jan. 1. This will help us accurately acknowledge your contributions. If you currently do not have envelopes, but would like to begin using them, please call Kim in the church office. Thanks! **PLEASE NOTE:** Per IRS regulations, donations must be given by **Dec. 31** to be considered a 2017 donation. Any donations received after that date will go on your 2018 contribution statement.

WEIHNACHTSGOTTESDIENST: Immanuel Ev. Lutheran Church in Terre Haute, IN invites you to their annual *German Christmas Service* on **Dec. 10** at 4:00 pm. Sing German hymns and carols, hear the Gospel and sermon in German, and enjoy some *Gemutlichkeit*. They will serve pastries, cookies, German Kaffee. An English translation of the liturgy will be provided as well as a synopsis of the sermon. One need not know German to enjoy this Service! Call 812-232-4972 for more info.

OH COME * LET US * *Adore* * * HIM

The Advent and Christmas season is a special time of year. Advent is the start of the church year, a time to prepare for the salvation coming to us through the anticipated Christ-child.

We will have three midweek *Advent Services* this season on Wednesdays: **Dec. 6, 13, & 20**. These are a chance for us to prepare our hearts to welcome the Babe of Bethlehem. It's also a chance to sing more of your favorite Advent and Christmas hymns, so please join us.

Decorations are a big part of Christmas celebrations, and we invite all members to come help decorate our sanctuary and facility on Saturday, **Dec. 2**. We'll begin at 9:00 am, and we're usually done by noon. Your help is greatly appreciated!



And thank you to everyone that donated poinsettias to adorn our altar area during the Christmas season.

We plan on *caroling* the shut-ins **Dec. 17**. We'll meet and leave from the church at 3:00 pm, then head out to sing for a couple of hours. We'll return for a soup supper. *Please join us!*



The **Sunday School Christmas Story** will be part of our morning Service at 9:30 am on Sunday, **Dec. 24**.

Our **Christmas Eve Candlelight Service** with Holy Communion is at 10 pm; come early to hear extra Christmas music.



I want to thank everyone in advance for their hard work and participation in our Advent and Christmas celebrations!!

-Tom Fricke, Board of Worship

PARISH EDUCATION NEWS:

- Thank you to those who participated in our Monical's Day in November. The funds that were raised will be used to support our summer VBS and other Parish Ed programs.
- Parish Ed will sponsor Christmas treat bags for children who participate in our Children's Christmas service at 9:30 am on **Dec 24**. This year, Danville Care Rehab will assist by decorating and packing the bags for the children. We thank them for their participation!
- Practice for the Children's Christmas service is Saturday, **Dec 23** from 10 am – noon with pizza served at 11:30.
- Parish Ed will meet next on **Jan 15**.



HERE'S WHAT'S HAPPENING IN...



*Twases before Christmas, 700 or so
When Isaiah, God's prophet, sat down and wrote
One of the messages God had him say
He told what would happen that first Christmas Day*

This is the opening stanza of the Children's Christmas Eve service. We hope you will join us as the Sunday School children will present the "Twases of Christmas" on Christmas Eve morning. Sunday School children will spend the month of December hearing the Christmas Gospel, as well as preparing to share "The TWASES of Christmas". There is no Sunday School on **Dec. 31**.

PLEASE NOTE: Be sure to keep all your valuables out of sight and your vehicle doors locked. We have had trouble in the past during this time of year; so we extend this word of caution!!

WOMEN'S GUILD: Ladies of Immanuel, you are all invited to the Women's Guild Christmas party on **Dec. 5** at 6 pm. Please bring a dish to pass; tableware & drinks are provided. At the party we will enjoy a delicious meal, have some seasonal entertainment, as well as a SHORT business meeting. We look forward to a great evening and hope to see many there!

INGATHERING: Our December ingathering or Christmas charity gift will be cash donations to provide a food basket and gift cards to help several struggling DLS families. Your gifts may be brought to the Christmas party or put in the mailboxes of Diana Pratt or Mary Powell and labeled as "Women's Guild Christmas Charity".

CHRISTMAS COOKIES: It is a tradition of the Women's Guild to remember our members who are homebound with Christmas cookies. Volunteers are needed to bake cookies and/or deliver them. Please sign up on the bulletin board to do one or both. Cookies should be brought to the all-purpose room anytime on

Dec. 19 or on **Dec. 20** before 9:30 am. Cookies can be picked up for delivery on **Dec. 20** in the afternoon or **Dec. 21** anytime. Call Diana Pratt for more info.

MITES: Remember to bring your mite box on **Dec. 3**, and empty it into the large one. Also, pick up a flier about missions that your mites are supporting. *Thanks!*

MEN'S CLUB CHRISTMAS PARTY is on **Dec. 11** at 6 pm. This is a potluck dinner and the meat and drinks will be provided. Signup to bring a dish on the bulletin board in the hall.

AMAZON SMILE: Online shoppers: please use *Amazon Smile*!! To make Immanuel your charity, go to the website: smile.amazon.com/ch/37-0806907; then shop and Amazon will donate a portion of your purchase price to Immanuel. It's a simple and automatic way for you to support Immanuel every time you shop, at no additional cost to you! *What a great gift for our church!!*

CAPITAL FUND CHRISTMAS TREE: There is a special tree in the Narthex for special year end gifts to the Capital Fund Drive; it has all blue ornaments (and no lights). This tree is special because each of the ornaments has a white tag with either a dollar amount (or left blank for you to fill in). There are special envelopes beside the tree. Please take an ornament as a remembrance and put the white tag with a check for the corresponding amount inside the envelope. Place the completed envelope in the collection plate. All donations will be used to build up our cash to pay for the school windows. See the Capital Fund Drive Report on this newsletter for more information on this project. Remember all donations to be counted in 2017 must be received in the church office by **Dec. 31** to be counted on your 2017 giving statement.



The Heidle family will again open the Parsonage for you to stop by Sunday afternoon **Dec. 10** from 1 to 4 pm. There will be cookies, treats, snacks and an opportunity to share some Christmas cheer with our Immanuel family!

DIRECTORY UPDATES: We have had some contact information changes since the publication of our church phone directory. Please note the following changes in your copy: **Enid White** is still at Hawthorne, but she has moved to Room #604; **Joe Hoytenga** has moved: his new address is 9015 225 Ave in Reed City, MI 49677 and his new phone number is 231-679-0653; **Shirley Gunia** has moved to a different nursing home: Palm Terrace, 1000 Palm Avenue, Mattoon, IL 61938; and **Tina Ammermann's** cell phone # is 260-8448. We will continue to update new or corrected contact information in the newsletter each month as it becomes available. Please contact Kim in the church office if your information changes or is listed incorrectly. *Thank you!*

*May you know the comfort and
joy of God's presence this
Christmas season and always!
Merry Christmas!*



STOCKING STUFFERS!! The December gift (scrip) card order is due to the church office by 1:30 pm **Dec. 11.** *These cards are great for Christmas gifts and stocking stuffers!!* This is an easy way to get something for everyone! Order blanks are on the table in the chapel hallway. Orders are not limited to the vendors listed on the order blank; if you want to order a vendor not listed, first see if it is available online at www.shopwithscrip.com. Write the name of the vendor, denomination of the gift card, number of cards wanted, and total amount on a blank line of the order form. There is a vendor list on the bulletin board in the chapel hallway. These orders will be available for pickup on **Dec. 17** or in the church office after that. Most of the local fast food/chain restaurants (with varying rates of profit to the church), plus Meijer, Wal-Mart, and Big R have cards available *every Sunday* and in the church office during the week. ***This is your LAST CHANCE to order before Christmas!!***

BOARD OF DIRECTORS SUMMARY:

- Discussion on improvement of communication between DLS and the congregations.
- Immanuel participated in the early discussions for the DLS budget. Early numbers were received and distributed for review/comment.
- Discussion about received bequests and how to manage them. The key point was to be sure to respond thankfully and ensure notice was given to the congregation. We will discuss further to develop a policy on how to reserve these funds in the accounting program. The desire is to provide specific items that will honor the individual.
- On a related item, a continued push for exploring an endowment fund is wise. This will require members to participate on a separate board, and we will need to seek out those who feel called to serve.
- Missions and Social Ministry reported that they were greatly pleased with the response of the congregation for the food pantry items.
- Some board members and Pastor have been contacted with concerns for safety in light of the event of the shooting in Texas. A discussion will be held with the ushers for appropriate safety measures to be put in place, such as locking doors, updating locking mechanisms, and a patrol of the parking lot.
- The Board of Directors will not meet in December.
- The next Board of Directors meeting in January will focus on the review of the updated numbers for the DLS budget and the preparation of items for the Voters' meeting in February.

CAPITAL FUND DRIVE COMMITTEE:

Since this is the last Newsletter of 2017, I'd like to recap the accomplishments. These accomplishments are entirely done through the generous giving of our congregation! Without these generous gifts of time, talents and donations since 2012, these projects wouldn't have been possible. The projects are:

- New Organ: \$18,565
- HVAC in Sanctuary and office wing: \$125,083
- Sanctuary lights: \$17, 373.62
- Sanctuary flat roof: \$13, 405
- Sanctuary AED: \$1,199 (funded through a grant from Vermilion Healthcare Foundation)
- Partial payment for playground: \$4,149.25
- Mortgage pay-down: \$104,735.10
- Parsonage:
 - New HVAC: \$6,650
 - New Roof: \$7,755
 - Attic Insulation: \$1,745
 - Electrical: \$1,321
- 2017 Projects completed:
 - New cafeteria stoves: \$9,561
 - Drainage tile: \$21,234
 - Parking lot resealing/stripping: \$8,960

Our next project is the replacement of the school windows. They have deteriorated over the years (about 60!), been repaired, and now need replacing. When it rains, one of the classrooms has to put towels on the ledge under the window to soak up the rain coming in! The tuck-pointing between the glass blocks is almost gone, and the caulking around the windows has become brittle. We discussed just doing the tuck-pointing and caulking and it was around \$16,000 and would still not correct the entire window problem. The same contractor that did the replacement windows at Danville High School gave us an estimate over \$100,000 for all of the windows. He is willing to work with us and do one window at a time; each window would take about a week to replace. Our new windows would look like the windows at the high school with some that open along the bottom for ventilation and emergency egress. The windows on the East side of the building are in worse shape so we will start with those. Each classroom window would be a little over \$10,000; the other windows are smaller and vary in price. This will also help lower our heating/ac bills since they are energy efficient. If you or a group of members would like to sponsor a window by raising the money for it, please contact Jo Van Hovel. This building needs to be maintained! Prior generations worked and sacrificed to build this school and church building, and it's up to us to preserve and improve our church home just as we would our own household. It's not too late to pledge or donate. All donations small and large are equally appreciated. Please call Jo Van Hovel with any questions.





PRESCHOOL 3 – MRS. MARXMAN

Merry Christmas! It's the season of joy and togetherness. We are busy decorating our classroom and the cafeteria with the sights of the season. Our classroom will transform into a makeshift Bethlehem town. The children interact with some simple activities that aids in relating the story of Jesus' birth in a hands-on approach, using our 5 senses to experience Christmas. The children should be able to answer the following questions at the end of December: What are angels and where do they come from? What is Bethlehem? Who is the Baby in the manger? When was Baby Jesus born? Our color this month is RED and our shape is the STAR and our number is FOUR. Swing by anytime you're in the neighborhood and we'll show you around. We have a new center designed by the children, it's a garage. We're having fun in it, creating, fixing, and working together.

PRESCHOOL 3/4 – MRS. HAMMER

December is another busy month for preschoolers. The children are learning songs for the Christmas program. We will be talking about bears and the letter B, and the letter C and all things Christmas. As we learn the letter J, we will learn about Jesus' birth. In Jesus time, we will talk about Advent and Jesus' birth. We welcomed a new student, Dolan Vickery, to our class. We also welcomed Mrs. Amanda Gaston as an aide. Season's Greetings!!

PRESCHOOL 4 – MRS. HEIDLE

It is hard to believe that December is here. This year is flying by. We will do the letter B for bear. We are learning about animals that hibernate, migrate, and adapt. We will learn the letter G when we talk about gingerbread; there are many stories about gingerbread people. We will also learn the letter J for Jesus. We will be learning about Advent, John the Baptist and Jesus' birth. We are excited to be learning our songs for our Christmas program – we love to be on the stage! We are sad to say goodbye to one of our friends, Finn. His family is moving to South Africa for work. God's blessings to you during this Christmas season!

KINDERGARTEN – MRS. SHOWERS

Kindergarten is ready for another busy month as we wrap up the first half of the school year. We will continue to learn the remainder of the alphabet and learn even more sight words to help improve our reading skills. In math, we will work with money, learning how to count it. Science introduces habitats characteristics that make up each habitat. We are learning all things Christmas and have many fun projects planned for December. Our Christmas Program is Dec. 14 at Trinity; please join us if you are able! God's blessings from the kindergarten class!

GRADE 1 – MISS FAUSER

The first graders are so excited! We welcomed two new students to our classroom family. Both students are wonderful additions to our school family. The first graders are also excited about Christmas. We are learning about Advent, and we are preparing our hearts and homes/classroom for Jesus. In science and social studies we are learning about habitats and homes. We will learn about what animals and humans need to survive in different habitats. The first graders are also working hard on learning more sight words and phonics rules to help us with our reading and writing. We keep practicing our writing by making our own books. We are awesome authors and illustrators. God's blessing to you from the first graders and Miss Fauser!

GRADE 2 – MRS. ROUSE

The second graders are ecstatic for the month of December. We look forward to Christmas and all the excitement that it will bring to our classroom and homes. In Religion, the students will begin their fourth unit, "The Faithless and the Faithful." God is faithful. He blesses those who trust in His Word. He is faithful even when we are faithless. In English and Reading, we will continue to concentrate on the eight parts of speech and the different parts of a story to help us become better writers. While in Science and Social Studies, we will focus on living things (animals and plants) in their environments and learn about the Earth's various landforms. Lastly, the 2nd graders look forward to a new style of writing-- cursive!

GRADES 3 & 4 – MRS. TIBBEN

Third and fourth graders are busy staying on top of many things as we continue to juggle practices and games this year. Third graders are beginning multiplication facts while fourth graders are using all four math operations in dividing and checking of long division. In social studies, both classes are memorizing states, capitals, and their abbreviations of our final region. We just completed a six hundred piece United States shape puzzle – thank you to Pat Hubner for her addition to our puzzle collection. It is insightful to see just who has the perseverance to keep working toward completion. A nativity-themed puzzle, with a large amount of hay, is on our horizon. We have also begun constructing a lap book depicting the Advent and Christmas symbols and their meanings. In this frenzied, increasingly dangerous world it is a great comfort to know that Jesus is our Immanuel, God with us. Merry Christmas!

GRADES 5 – MR. YAGOW

The fifth grade students continue to take advantage of the small student to teacher ratio. Each student receives considerable one on one attention which often allows for greater learning. In the month ahead, students will be moving forward with decimal operations in math and the novel reading of Sign of the Beaver. It is a survival book that ties in Native American life with New England colonization. The students were successful in applying the forces of friction and gravity in creating a ramp that would achieve the slowest time possible. Zachary Davis produced the slowest time of 21.76 seconds. The joy of the Christ Child and the salvation He brings will highlight our religious lessons and devotions. We hope it is a highlight for you and your family too. Congrats to our 5th and 8th grade Bible Bowl teams who both placed second at the Bible Bowl at Springfield Lutheran High School on November 18. Members of our two teams included Brendon Gieseke, Piper Hiser, Ryan Troxel, Kaitlyn Stack, Maci Dale, Joshua Gernand, Noah Christensen, and Makenzie Flessner.

GRADE 6 (HOMEROOM) – MRS. HUFF

In December, the sixth graders will study the early civilizations and empires of India. We will learn about many traditions from long ago and how they are still practiced today. Seventh and eighth grade will conclude their study of westward expansion including lessons on the Gold Rush and Manifest Destiny. Math lessons for sixth graders will focus on understanding variables and how they help us solve problems. Similarly, the pre-algebra class will use formulas to solve equations with variables. Algebra students use ratios and proportions to create drawings and blueprints. Finally, as we prepare to celebrate the birth of our Savior, the sixth graders will study the time of the judges in the Old Testament. We will learn how God forgave the children of Israel each time they turned away from Him and continued to remind them of His promise to send a Savior.

GRADE 7 & 8 (HOMEROOM) – MRS. WRIGHT

Grades 7/8 literature students just finished The Hound of the Baskervilles and look forward to watching the classic film version in December. Our next novel will be Anne of Green Gables. Grades 7/8 science has been doing a whitetail deer unit. Students have learned about deer digestion, antler growth, predators, reasons for the deer population explosion in Illinois, etc. Once the deer unit is complete, studies will move to body systems. These units are often a favorite of the students. Watch for cross-curricular artwork coming soon! Grade 6 science continues their earth science unit with lessons on the solar system and the Earth's interior. This time of year reminds us of the perfect love of our God. He sent a much needed Savior that we may find peace, in a fallen world and even with our own sinful flesh. O Come. O Come, Emmanuel!

Danville Lutheran School News

DATES TO REMEMBER:

- I&I Basketball Tournament, **Dec. 2-3**
- Preschool Christmas Program, **Dec. 12**
- K – 8 Christmas Program, **Dec. 14**
- No School for winter break, **Dec. 20 – Jan. 2**



You are invited to our DLS Christmas Concerts! The preschool program is **Dec. 12** at 6:30 pm in our Immanuel gym; and our K – 8 program is on **Dec. 14** at 6:30 pm at Trinity's gym. *Please come – you don't want to miss it!*

GO WARRIORS!

Come support our DLS Warriors at their December Basketball games! The I & I Tournament is **Dec. 2 – 3** at Trinity. Our Boys Varsity team will play on Saturday at 9:30 am and 3:45 pm. They play on **Dec. 5** (vs. First Baptist) and **Dec. 9** (vs. St. John's Buckley), both of those games are at Immanuel with the JV game beginning at 6 pm and the Varsity team plays at 7:15. *Go Warriors!!*



POINSETTIAS: *Thank you to the many of you who continue to support DLS through our fundraisers!!* If you ordered Christmas Poinsettias for personal use or gifts, your orders will be ready for pick up on **Dec. 8** at Immanuel. If you ordered poinsettias for the altar at Trinity or Immanuel, you do not need to come pick them up – they will be delivered to the church. *Thank you!*

5th graders Aaliyah Lang and Zachary Davis

Aaliyah, Zachary, and the rest of the 5th grade class were assigned the task of building a marble ramp – but there was a catch! They had to build one using the forces of friction and gravity to achieve the slowest possible time!

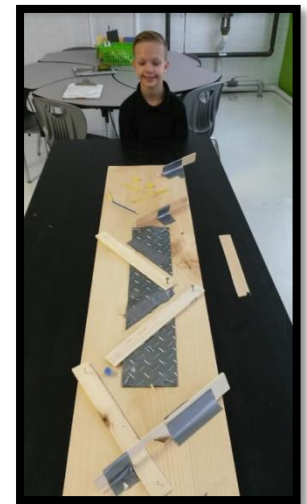
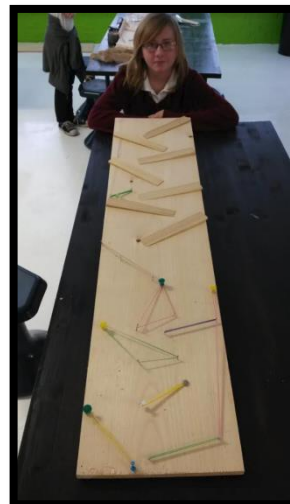



Lutheran Ministries Media, Inc.
5 Martin Luther Drive, Ft Wayne, IN 46825-4996

Toll free: 888-286-8002

Email: info@worshipforshutins.org

Website: www.worshipforshutins.org

Making a Christ-like Difference!

- ✓ 30-minute Lutheran Church-Missouri Synod worship service
- ✓ Produced by Lutherans for the homebound, hospitalized, ...
- ✓ Includes the Gospel, Epistle, and Sermon by LCMS Pastors
- ✓ Music by choirs, soloists, and small groups



“Worship for Shut-Ins” Award Winning Television Ministry

- ➔ **Broadcasts weekly on:** **Sundays 7:00 am – WTWO-TV2 (NBC)**
 Sundays 10:30 am – TCT Network - DIRECTV channel 377
- ➔ **Broadcasts Nationwide ever Sunday:** **DIRECTV channel 377**
 11:30 am Eastern; 10:30 am Central; 9:30 am Mountain; 8:30 am Pacific
- ➔ **Tune in any time online:** **www.worshipforshutins.org**

December 2017

December 3 (Mark 13:29, 33)

“Do We or Don’t We?”

By Rev. Dr. Thomas Ahlersmeyer, Holy Cross Lutheran Church~Fort Wayne, IN

What do we or don’t we know about the second coming of Jesus? How does what we know and don’t know shape our daily lives?

December 10 (Mark 1:4)

“The Trailblazer”

By Rev. James L. Elsner, Prince of Peace Lutheran Church~Stroh, IN

The life of a trailblazer is risky! It takes courage to do something new – something that’s right and good. John the Baptist was a bold trailblazer for Jesus. He shows us the way for making things new again!

December 17 (Isaiah 61:1-4, 8-11)

“Good News for a Change!”

By Rev. William Mueller, Suburban Bethlehem Church~Fort Wayne, IN

In God’s Word, we read how we will have troubles in this world, but God encourages us to take heart because He has overcome the world. It is true that we know all too easily how wicked this world can be. But God has good news for us – good news of such a nature and to such an extent that our lives will forever be changed!

December 24 (Luke 1:26-38)

“A Great Announcement”

By Rev. Dr. Walter A. Maier III, Concordia Theological Seminary~Fort Wayne, IN

The angel Gabriel made a great announcement to Mary. This story brings us comfort and joy, as we consider the way the announcement was made, what was announced, and how God prepared Mary for the role announced to her.

December 31 (Luke 2:22-40)

“Mother and Son”

By Rev. Paul E. Shoemaker, Emanuel Lutheran Church~New Haven, IN

When Mary and Joseph brought the infant Jesus to Jerusalem Simeon confessed: “*My eyes have seen Your salvation.*” Jesus is our salvation. He has come to “*redeem those who were under the law.*”

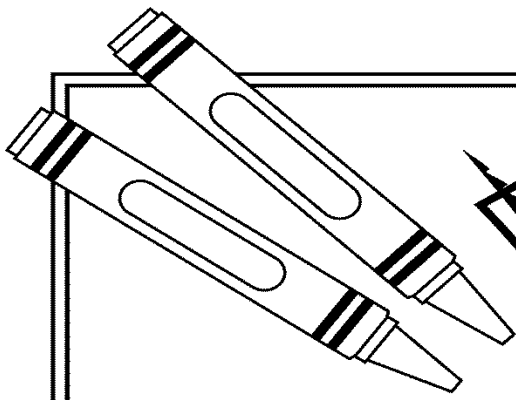

PUZZLE

JOURNEY TO BETHLEHEM

In the Christmas story in Luke 2, an angel tells some shepherds to go see baby Jesus in Bethlehem.



START

Directions: Follow the maze to arrive in Bethlehem.

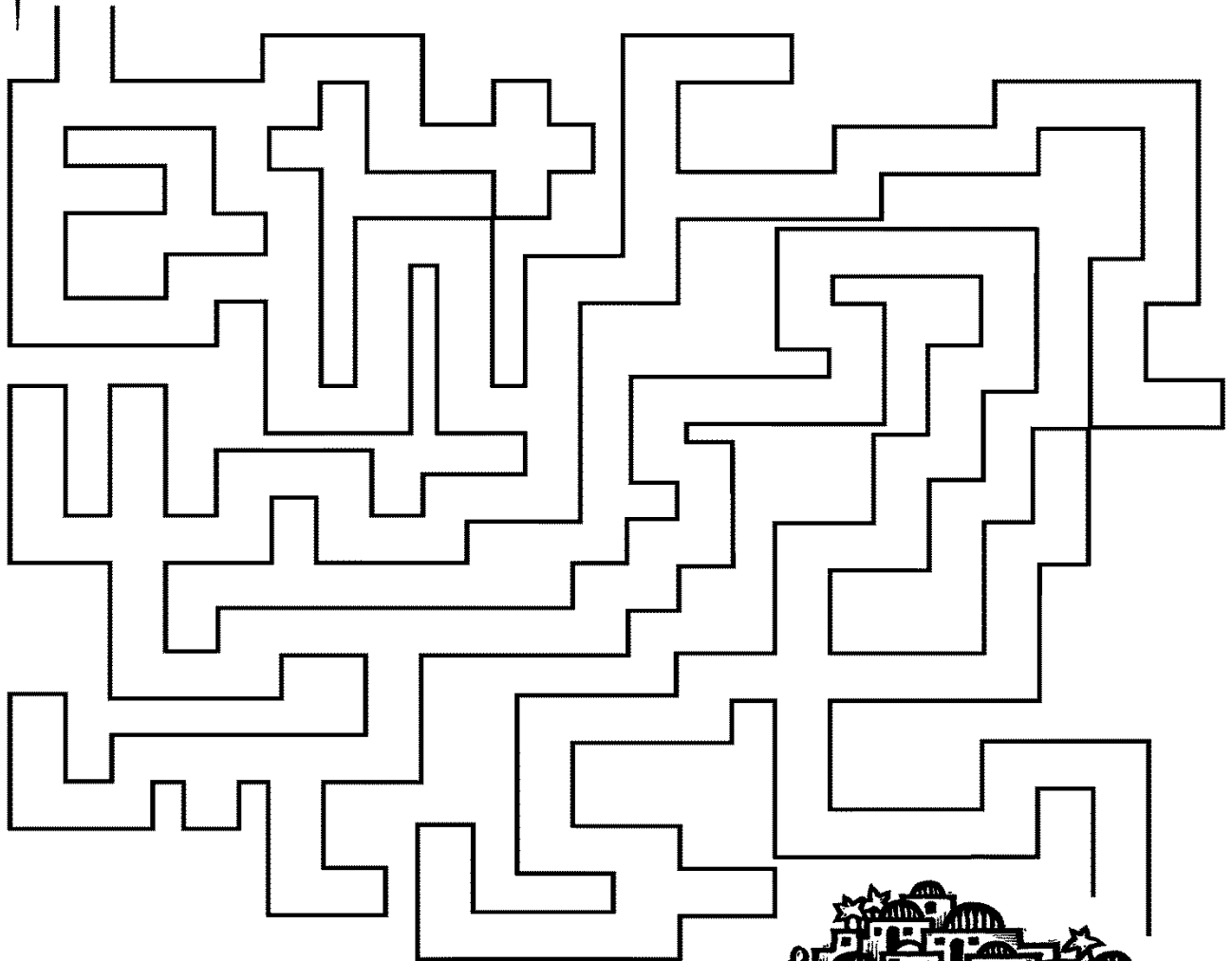

BETHLEHEM



Serving in...

December

Elders

Dec.	3	Ken Kuhn
	10	John Albers
	17	David Ammermann
9:30 am	24	Scott Burgess
10:00 pm	24	John Albers
	31	Don DeMoss

Communion Assistants

Dec.	3	Kurt Thornsborough, Scott Burgess
	17	Jerry Connolly, Roger Dahlenburg
10 pm	24	Roger Dahlenburg, Charles Vollmer
	31	Don DeMoss, Josh Christensen

Ushers

Dec.		Team "F"
		Capt. Bruce Huff, Tom Farrell, Dwain Dixon, John Albers, Al Julian

Note: Advent and Special Services:

December 6	7:00 pm	Team "B"
December 13	7:00 pm	Team "C"
December 20	7:00 pm	Team "D"
December 24	10:00 pm	Team "E"

Lay Readers

Dec.	3	Bill Schuring
7:00 pm	6	John and Terri Albers
	10	Janet Terry
7:00 pm	13	David and Tina Ammermann
	17	Kurt and Debbie Thornsborough
7:00 pm	20	Bruce Burton
	24	Bob and Kathy Wakeley
	31	Jerry Young

Greeters

Dec.	3	Narthex	Joe Hoitenga John & Marcy Heeren
		Chapel	Kitty Lee
10	Narthex	Charles Vollmer family	
	Chapel	Charlotte Schendel	
17	Narthex	Bill & Joyce Martin	
	Chapel	Marlon & Marian Heideman	
24	Narthex	Gary & Sarah Stuhr	
	Chapel	Carol Johnston	
31	Narthex	Deneen Schendel Family	
	Chapel	Dianne Seibert, Roger Seibert	

Acolytes

	Sundays	Special Services (7pm)		
Dec.	3	Josey Clem	6	Noah Christensen
	10	Quentin Alblinger	13	Ethan Connolly
	17	Aidin Stuhr	20	Hannah Christensen
9:30 am	24	Tiffany Walters		
10 pm	24	Noah Acree		
	31	Chris DeMoss		

Altar Guild

Dec. Terri Albers, Carrie Farrell, Kathy Cox

Money Counters

Dec. Team "C" Mary Powell, Dianne Seibert



OFFICIAL ACTS

Baptisms

Spencer Showers
Decklan Weddle

Deaths

Betsy Dillon
Marjorie Felgenhauer

Transfer Out

Lisa Wilkus and Family
Joe Hoitenga

Membership Release

Gregg and Judy Sacotnik

This Newsletter Sponsored By:

Arnold's Office Supply, Inc.

446-9693 arnoldsofficesupply.com

Locally Owned ... Gary & Sarah Stuhr

Bible Quiz

After Mary learned she was pregnant with God's Son, what relative — also miraculously pregnant — did she go visit?

- A. Esther
- B. Elizabeth
- C. Anne
- D. Anna



Answer: B (See Luke 1:39-41.)



"At least they saved themselves a co-pay."

Immanuel Messenger

GOD WITH US



December 2017

Immanuel Lutheran Church LCMs
 1930 North Bowman Avenue
 Danville, Illinois 61832-2298
 Change Service Requested

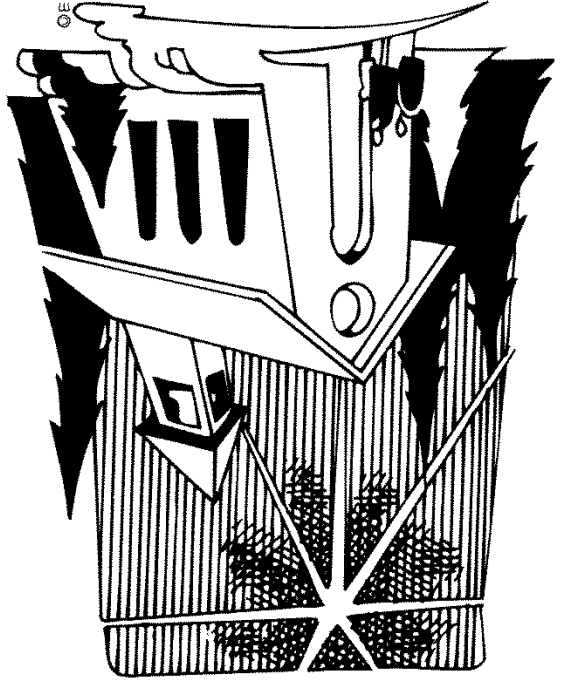

Non-Profit Organization
 U.S. Postage Paid
 Danville, Illinois 61832-2298
 U.S.P.S. Permit No. 333

Our December 2017 newsletter
 prepared prayerfully for:

This newsletter also available on our website:
www.ilcdanville.com

1930 N. Bowman Ave.
 Danville, IL 61832
www.ilcdanville.com
 217.442-5675
 Fax: 217.442-3827
 Danville Lutheran School
 217.442-5036
 Pastor Michael Heidle
 Parsonage: 431-4844

Worship Schedule
 Sunday Mornings
 Dec. 3, 10, 17, 24 & 31
 9:30 am
 Evenings
 Dec. 6, 13 & 20 at 7pm
 Dec. 24 at 10:00 pm
 Dec. 27 at 5:00 pm

Communion Schedule
 December 3, 17 & 31
 9:30 am
 Dec. 24 10:00 pm
 Dec. 27 5:00 pm

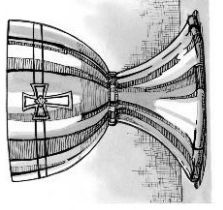

Worship